

Get your quotation directly from us!

Przedsiębiorstwo Produkcyjno-Handlowe

DANKROS Spółka z o.o.

Wood for you

Dankros company arised in 1991. Which has three productive plants situated in south-east Poland. 60 % of our products are for export, mainly to Denmark, Italy, Germany, France, Austria, Spain and China. We offer coniferous planking, like coniferous of: pine, fir-tree and spruce and leafy - beech. We make services in wide range for individual and wholesale recipients.



OUR ACTIVITY INCLUDES

- production of: constructional - skeleton timber, building timber (rafter framing, squared timber, battens, planking)
- pallets and elements of pallets,
- elements of packing,
- semi-finished products for woodwork
- beech ruffles,
- pine and beech furniture elemetns,
- chalets,
- summerhouses,
- palisade,
- garden program (fences, beds, composters, doghouses and swings),
- sound-absorbing panels which are put alongside highway,
- sticks beech plates,
- elements of frame houses.



OUR TECHNOLOGICAL POTENTIAL

- plunge impregnation,
- vacuum-pressure impregnation in autoclaves by standards DIN 68800, NEN 2945, EN351-2,
- wood drying in 18 drying chambers which are computer-controlled,
- beech wood stewing,
- planing,
- polishing,
- milling.



DANKROS Sp. z o.o.

Ustjanowa Górna 98 B, 38-700 Ustrzyki Dolne, Poland
tel./fax.: +48 013 461 1844; +48 013 461 1094
NIP: PL 6890001053 KRS: 0000144477 REGON: 004015903
e-mail: dankros@dankros.com www.dankros.com

Copyright 2009 Dankros Sp. z o.o.

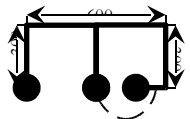
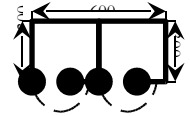
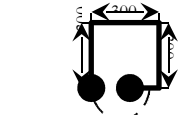
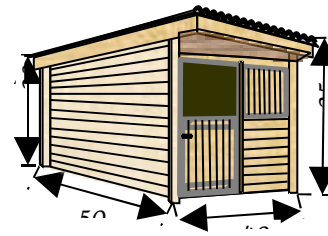

MODULAR STABLE BOXES

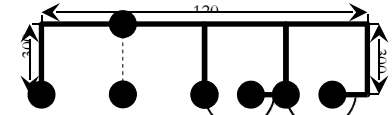

FENCES

GATES

And much more ...

Dankros Ireland Agency

dankros@dublin.ie
00353 86 2368431

Send your inquire

dankros@dublin.ie

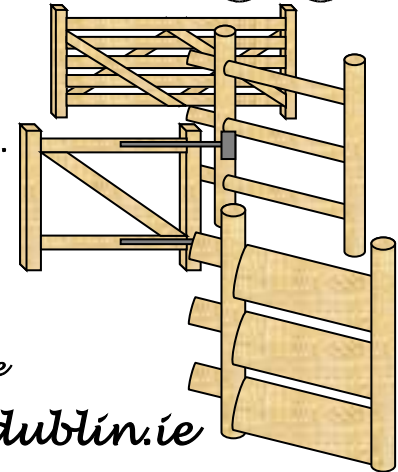

Get your quotation directly from us!

Przedsiębiorstwo Produkcyjno-Handlowe

DANKROS Spółka z o.o.

Wood for you

Dankros company arised in 1991. Which has three productive plants situated in south-east Poland. 60 % of our products are for export, mainly to Denmark, Italy, Germany, France, Austria, Spain and China. We offer coniferous planking, like coniferous of: pine, fir-tree and spruce and leafy - beech. We make services in wide range for individual and wholesale recipients.



OUR ACTIVITY INCLUDES

- production of: constructional - skeleton timber, building timber (rafter framing, squared timber, battens, planking)
- pallets and elements of pallets,
- elements of packing,
- semi-finished products for woodwork
- beech ruffles,
- pine and beech furniture elemetns,
- chalets,
- summerhouses,
- palisade,
- garden program (fences, beds, composters, doghouses and swings),
- sound-absorbing panels which are put alongside highway,
- sticks beech plates,
- elements of frame houses.



OUR TECHNOLOGICAL POTENTIAL

- plunge impregnation,
- vacuum-pressure impregnation in autoclaves by standards DIN 68800, NEN 2945, EN351-2,
- wood drying in 18 drying chambers which are computer-controlled,
- beech wood stewing,
- planing,
- polishing,
- milling.



DANKROS Sp. z o.o.

Ustjanowa Górna 98 B, 38-700 Ustrzyki Dolne, Poland
tel./fax.: +48 013 461 1844; +48 013 461 1094
NIP: PL 6890001053 KRS: 0000144477 REGON: 004015903
e-mail: dankros@dankros.com www.dankros.com

Copyright 2009 Dankros Sp. z o.o.

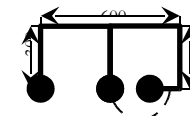
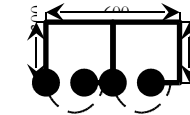
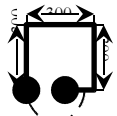
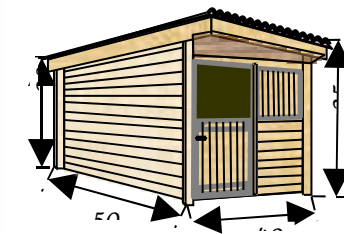

MODULAR STABLE BOXES

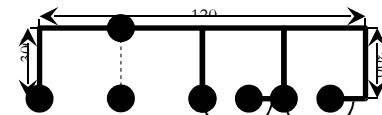

FENCES

GATES

And much more ...

Dankros Ireland Agency

dankros@dublin.ie
00353 86 2368431

Send your inquire

dankros@dublin.ie

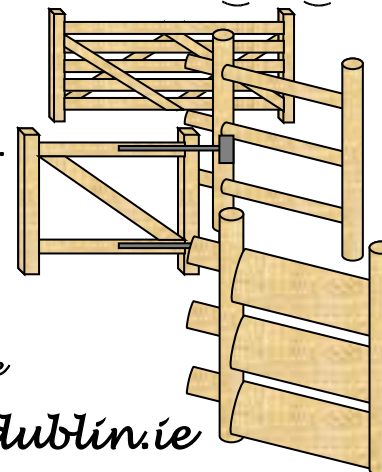

WOODEN FENCES,
pressure treated timber, pine, class IV
CLÔTURE BOIS
traité autoclave cl. IV

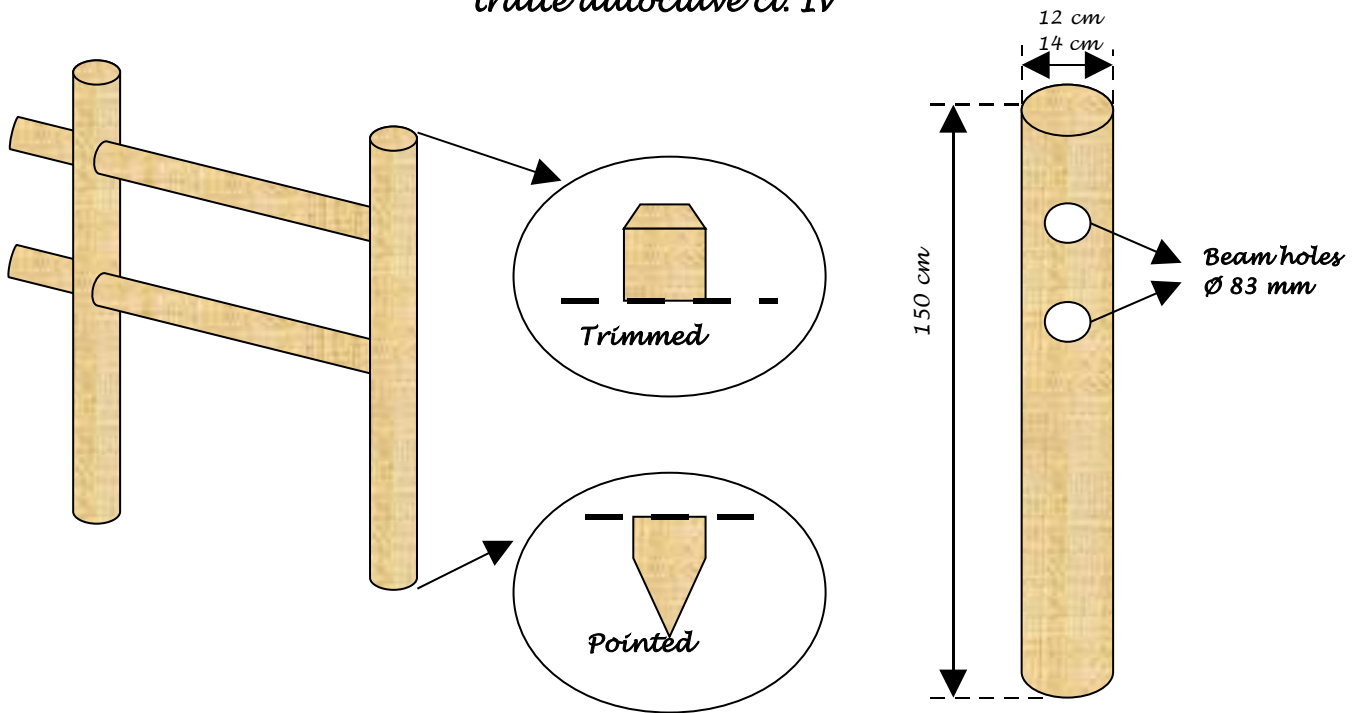

Art. 16.1 - Fence:

- wooden post pointed \varnothing 12 cm, height 150 cm
- 2 cross beams \varnothing 8 cm, length 250 cm

Art. 16.2 - Fence:

- wooden post pointed \varnothing 12 cm, height 200 cm
- 2 cross beams \varnothing 8 cm, length 250 cm

Art. 16.3 - Fence:

- wooden post pointed \varnothing 14 cm, height 150 cm
- 2 cross beams \varnothing 8 cm, length 250 cm

Art. 16.4 - Fence:

- wooden post \varnothing 14 cm, height 200 cm
- 2 cross beams \varnothing 8 cm, length 250 cm

WOODEN FENCES,
pressure treated timber, pine, class IV
CLÔTURE BOIS traité autoclave cl. IV

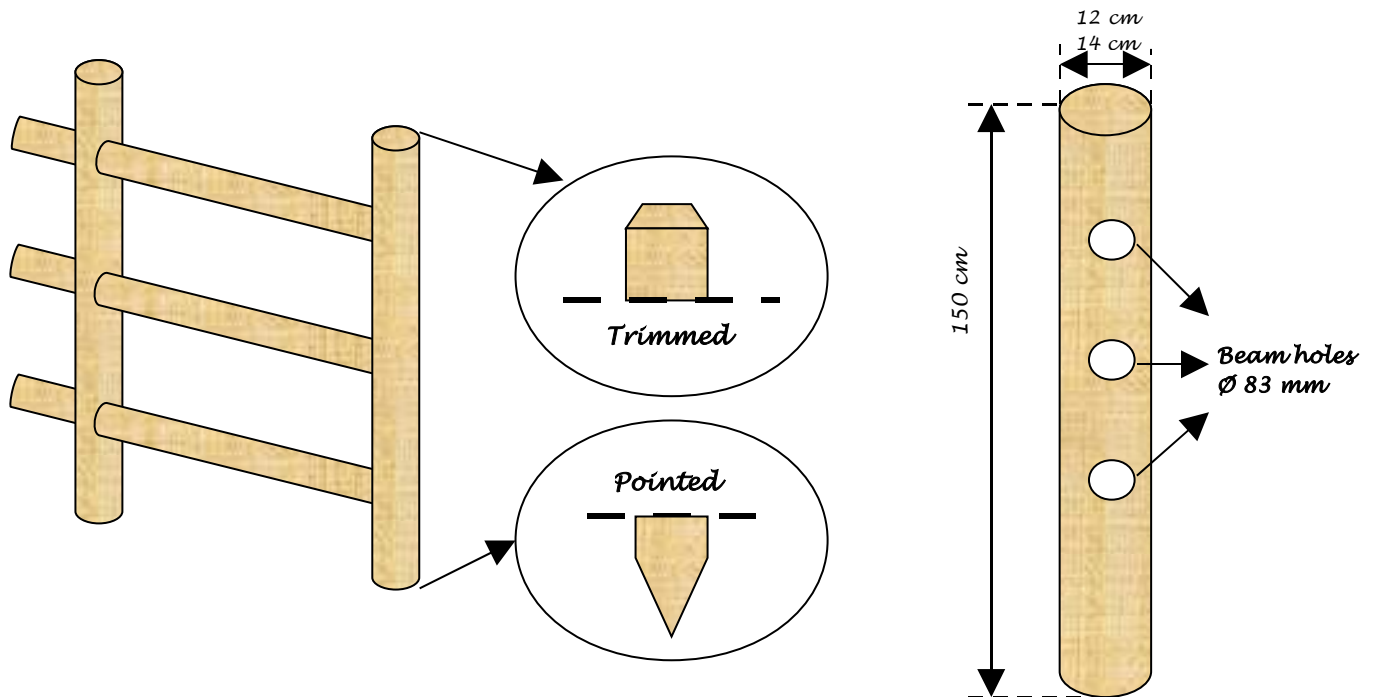

Art. 17.1 - Fence:

- wooden post pointed \varnothing 12 cm, height 150 cm
- 3 cross beams \varnothing 8 cm, Length 250 cm

Art. 17.2 - Fence:

- wooden post pointed \varnothing 12 cm, height 200 cm
- 3 cross beams \varnothing 8 cm, length 250 cm

Art. 17.3 - Fence:

- wooden post pointed \varnothing 14 cm, height 150 cm
- 3 cross beams \varnothing 8 cm, length 250 cm

Art. 17.4 - Fence:

- wooden post pointed \varnothing 14 cm, height 200 cm
- 3 beams \varnothing 8 cm, Length 250 cm

WOODEN FENCES,
pressure treated timber, pine, class IV
 CLÔTURE BOIS traité autoclave cl. IV

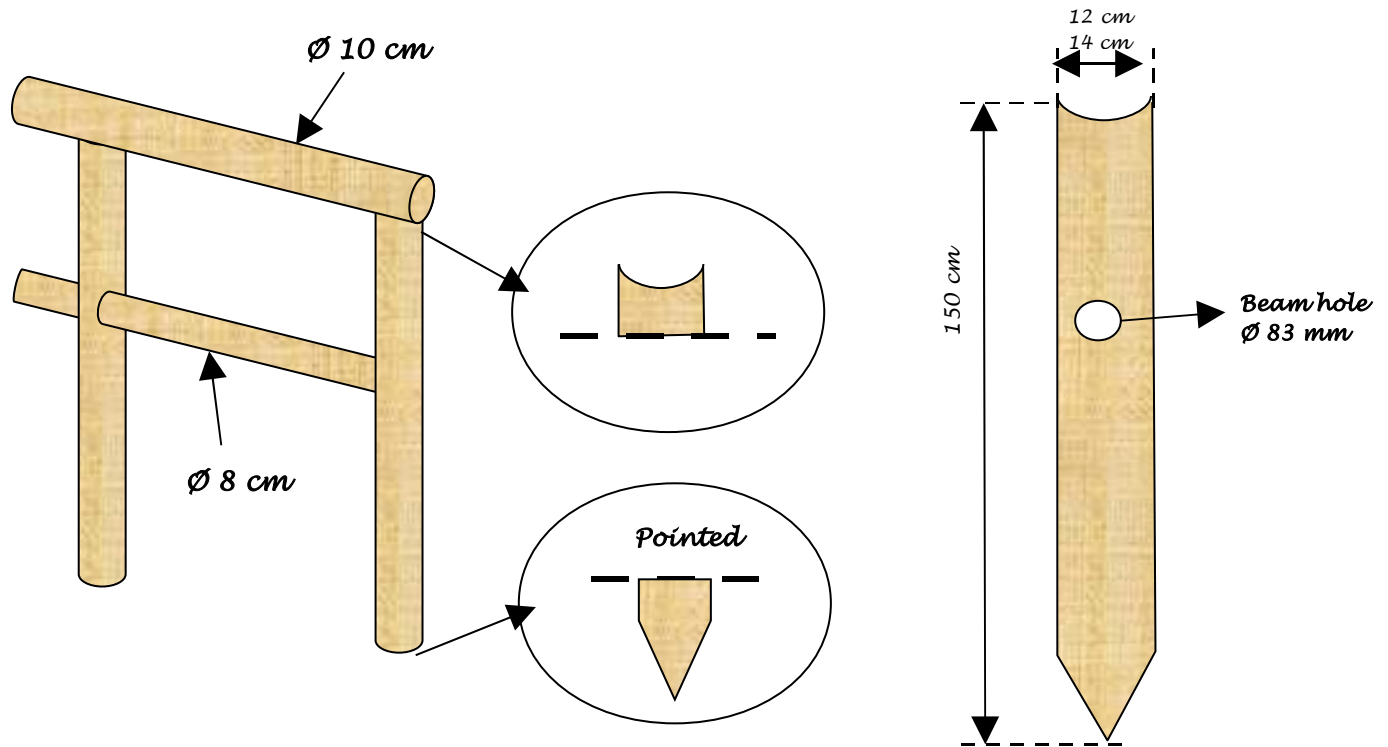

Art. 18.1 - Fence:

- wooden post pointed \varnothing 12 cm, height 150 cm
- 1 cross beam \varnothing 8 cm, Length 250 cm
- 1 movable cross beam \varnothing 10 cm, Length 250 cm

Art. 18.2 - Fence:

- wooden post pointed \varnothing 14 cm, height 200 cm
- 1 cross beam \varnothing 8 cm, Length 250 cm
- 1 movable cross beam \varnothing 10 cm, Length 250 cm

WOODEN FENCES, *pressure treated timber, pine, class IV*

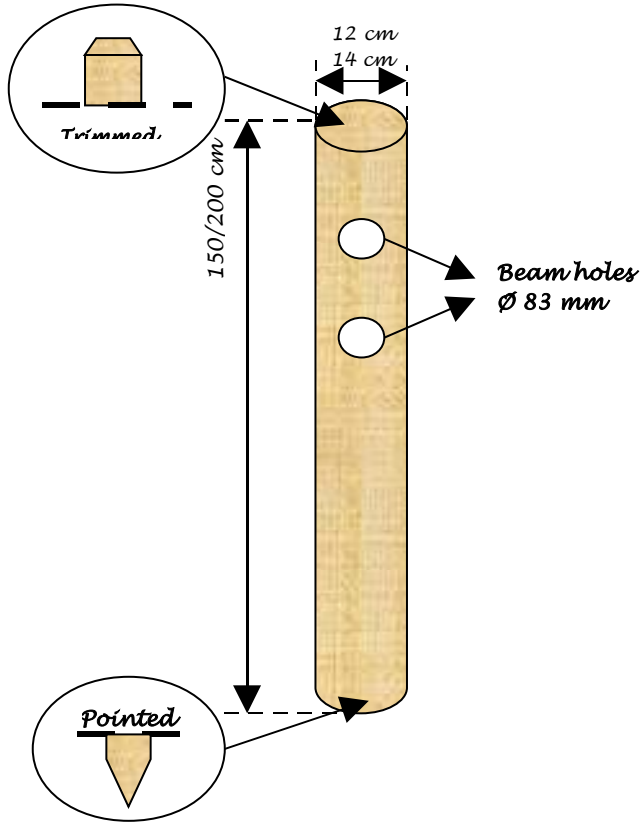

Art. 19.1 - *Wooden post, pointed*

- Ø 12 cm, height 150 cm
- 2 beam holes

Art. 19.2 - *Wooden post, pointed:*

- Ø 12 cm, height 200 cm
- 2 beam holes

Art. 19.3 - *Wooden post, pointed:*

- Ø 14 cm, height 150 cm
- 2 beam holes

Art. 19.4 - *Wooden post, pointed:*

- Ø 14 cm, height 200 cm
- 2 beam holes

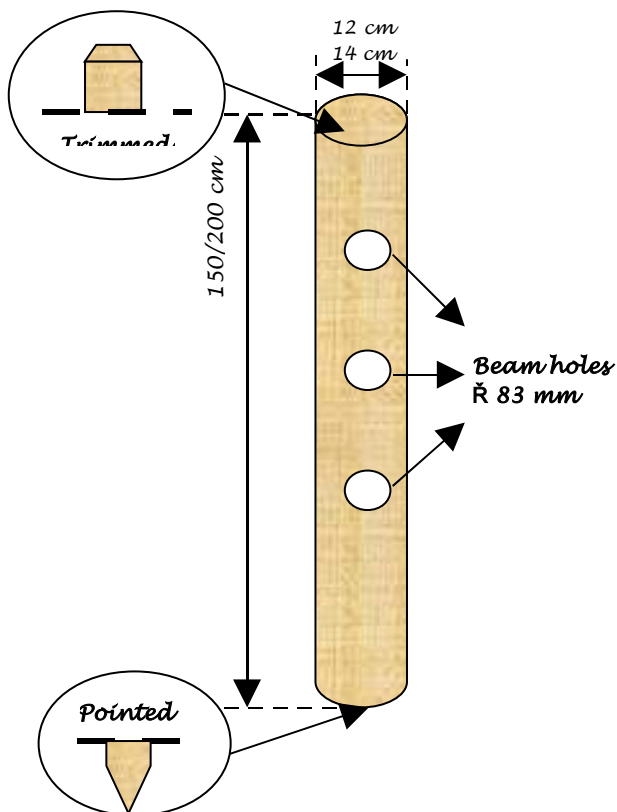

Art. 19.5 - *Wooden post, pointed:*

- Ø 12 cm, height 150 cm
- 3 beam holes

Art. 19.6 - *Wooden post, pointed:*

- Ø 12 cm, height 200 cm
- 3 beam holes

Art. 19.7 - *Wooden post, pointed:*

- Ø 14 cm, height 150 cm

- 3 beam holes

Art. 19.8 - Wooden post, pointed:

— \varnothing 14 cm, height 200 cm
- 3 beam holes

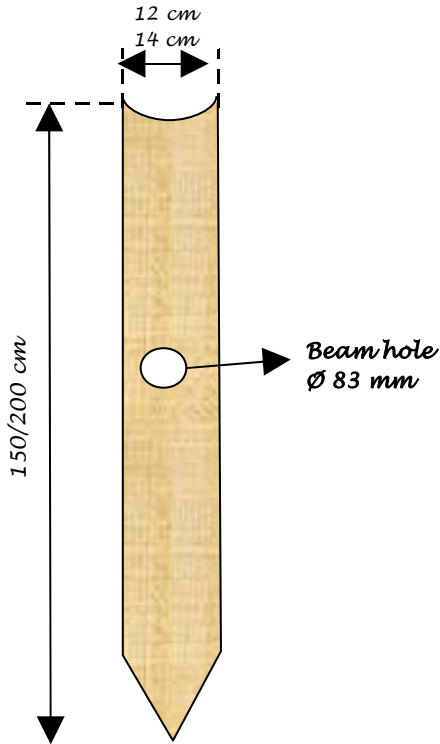

Art. 19.9 - Wooden post, pointed:

— \varnothing 12 cm, height 150 cm
- 1 beam hole

Art. 19.10 - Wooden post, pointed:

— \varnothing 12 cm, height 200 cm
- 1 beam hole

Art. 19.11 - Wooden post, pointed:

— \varnothing 14 cm, height 150 cm
- 1 beam hole

Art. 19.12 - Wooden post, pointed:

— \varnothing 14 cm, height 200 cm
- 1 beam hole

Art. 19.13 - Cross beam

— \varnothing 8 cm, length 200 cm

Art. 19.14 - Cross beam

— \varnothing 8 cm, Length 250 cm

Art. 19.15 - Cross beam

— \varnothing 8 cm, Length 300 cm

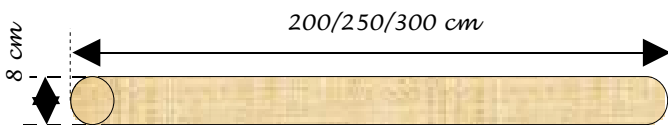

Art. 19.16 - Cross beam

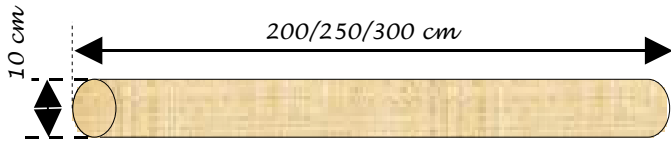

— \varnothing 10 cm, Length 200 cm

Art. 19.17 - Cross beam

— \varnothing 10 cm, Length 250 cm

Art. 19.18 - Cross beam

— \varnothing 10 cm, Length 300 cm



WOODEN FENCES,
pressure treated timber, pine, class IV
ÉLÉMENTS DE CLÔTURES BOIS traité autoclave cl. IV

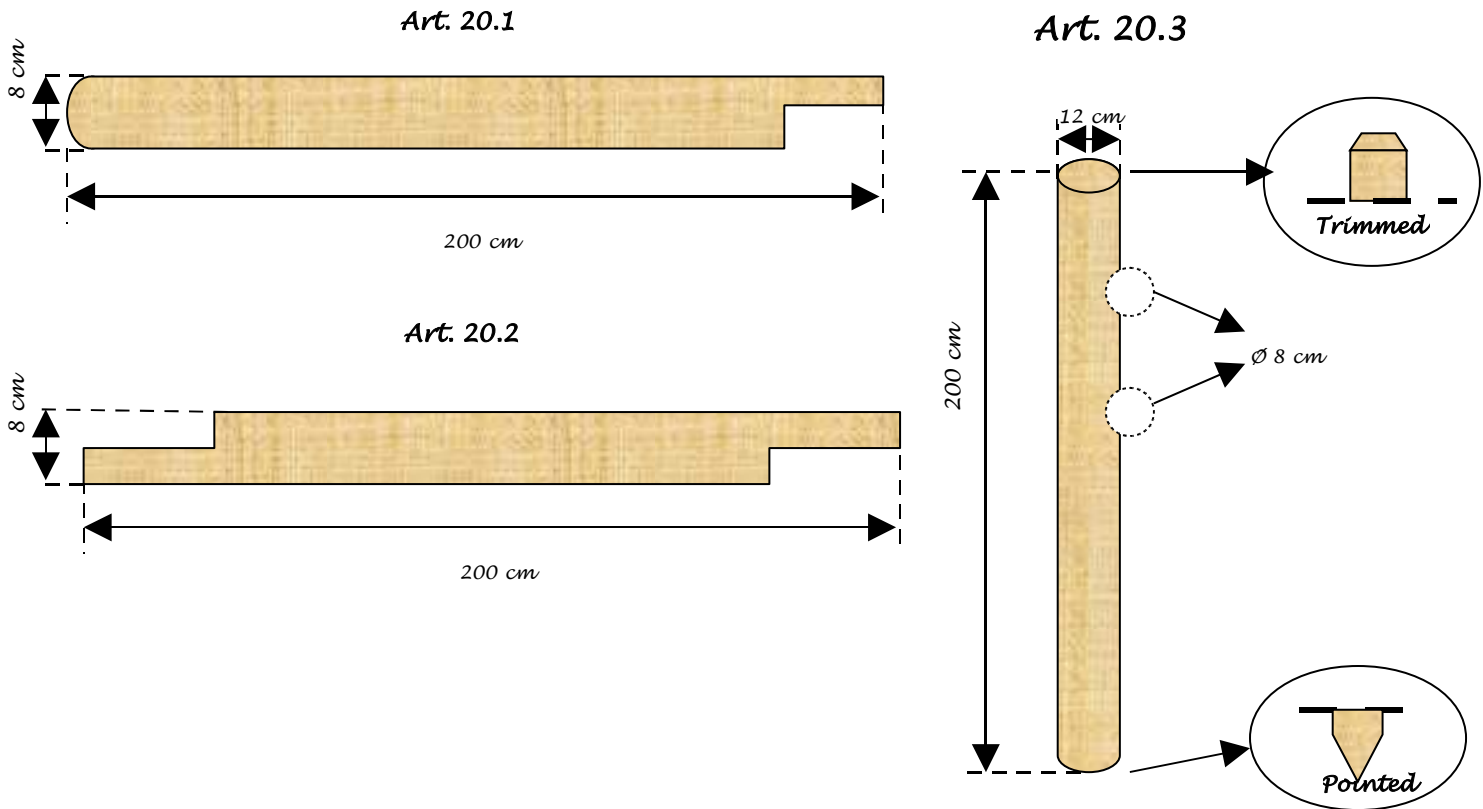

Art. 20.1 - Cross beam, square section, 1 side rounded:

— section 8x8 cm, length 200 cm

Art. 20.2 - Cross beam, square section, cut to joint 2 sides:

— section 8x8 cm, length 200 cm

Art. 20.3 - wooden post pointed:

— \varnothing 12 cm, height 200 cm

WOODEN GATE,
pressure treated timber, pine, class IV
BOIS
traité autoclave cl. IV

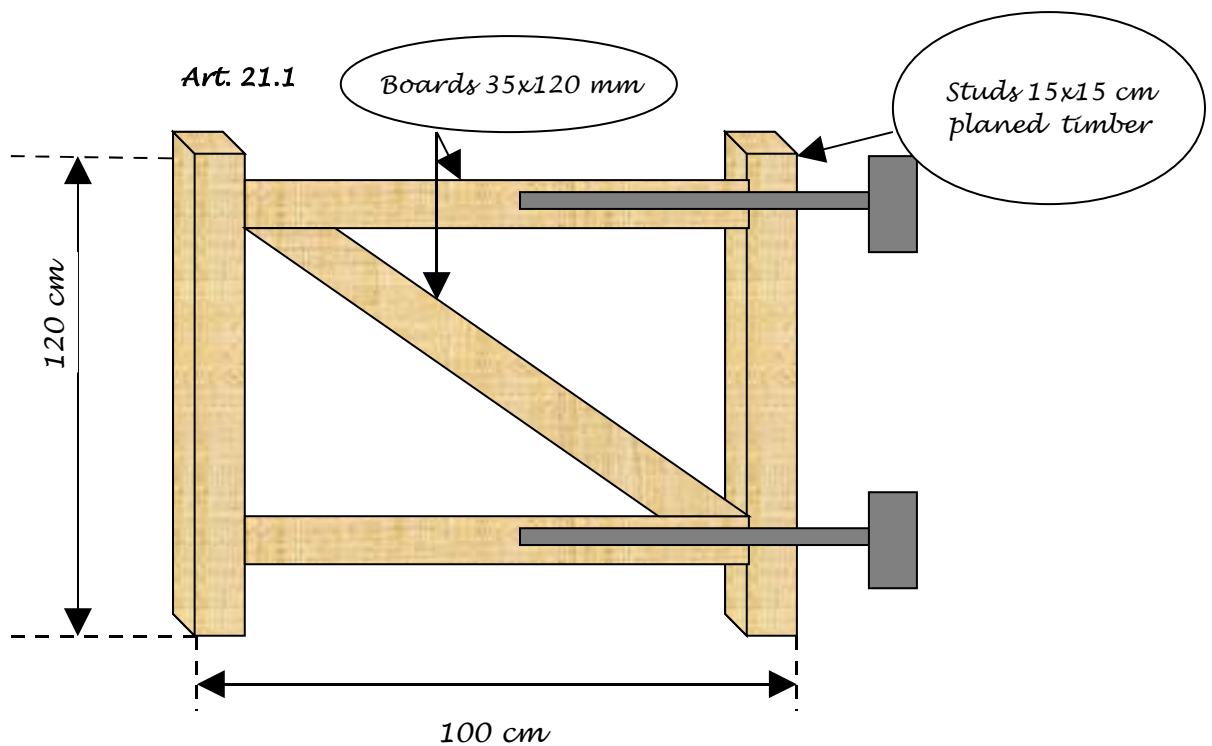

Art. 21.1 - GATE

- 2 square section, planed studs 15x15 cm, height 120 cm
- 3 boards 35x120 mm
- hardware

WOODEN GATE,
pressure treated timber, pine, class IV
BARRIÈRE BOIS traité autoclave cl. IV

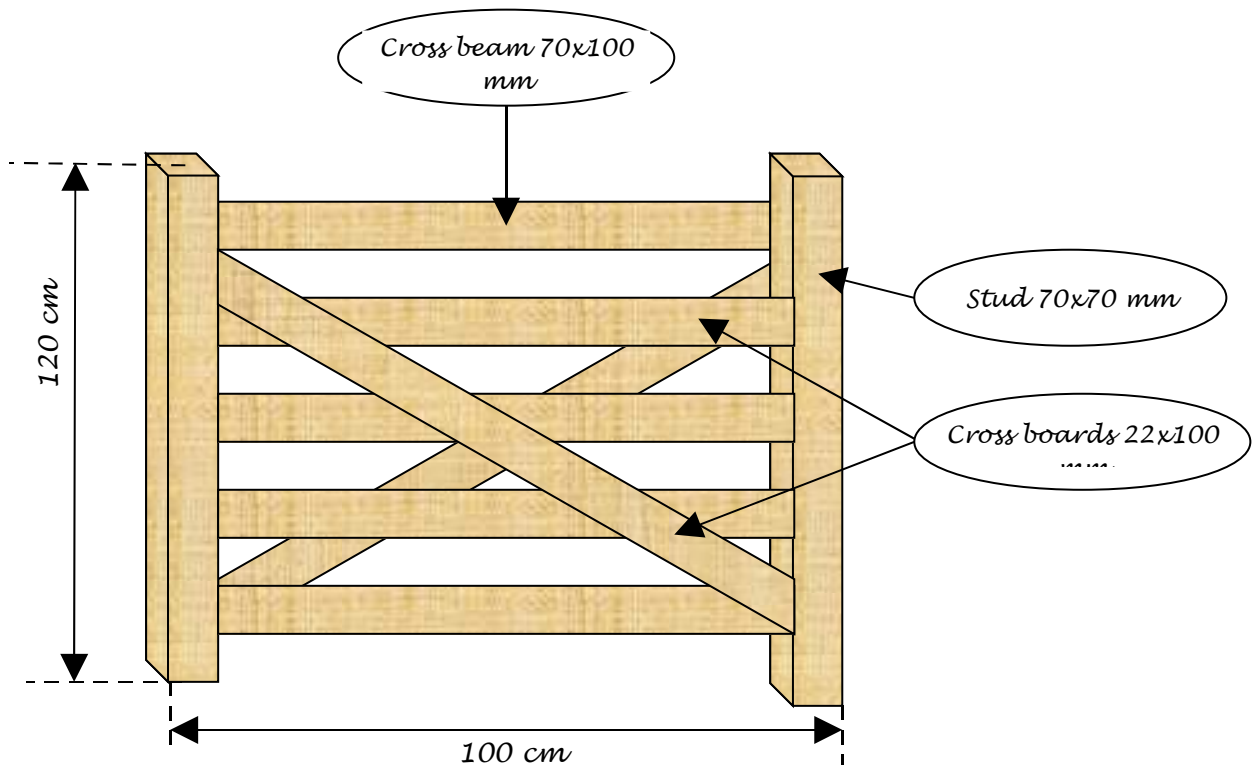

Art. 22.1 - Gate 120 x 100 cm:

- 2 studs 7x7 cm, height 120 cm
- 1 Cross beam, section 70x100 mm
- 6 Cross boards, section 22x100 mm

Art. 22.2 - Gate 120 x 200 cm:

- 2 studs 7x7 cm, height 120 cm
- 1 Cross beam, section 70x100 mm
- 6 Cross boards, section 22x100 mm

WOODEN GATES,
pressure treated timber, pine, class IV
BARRIÈRE
traité autoclave cl. IV

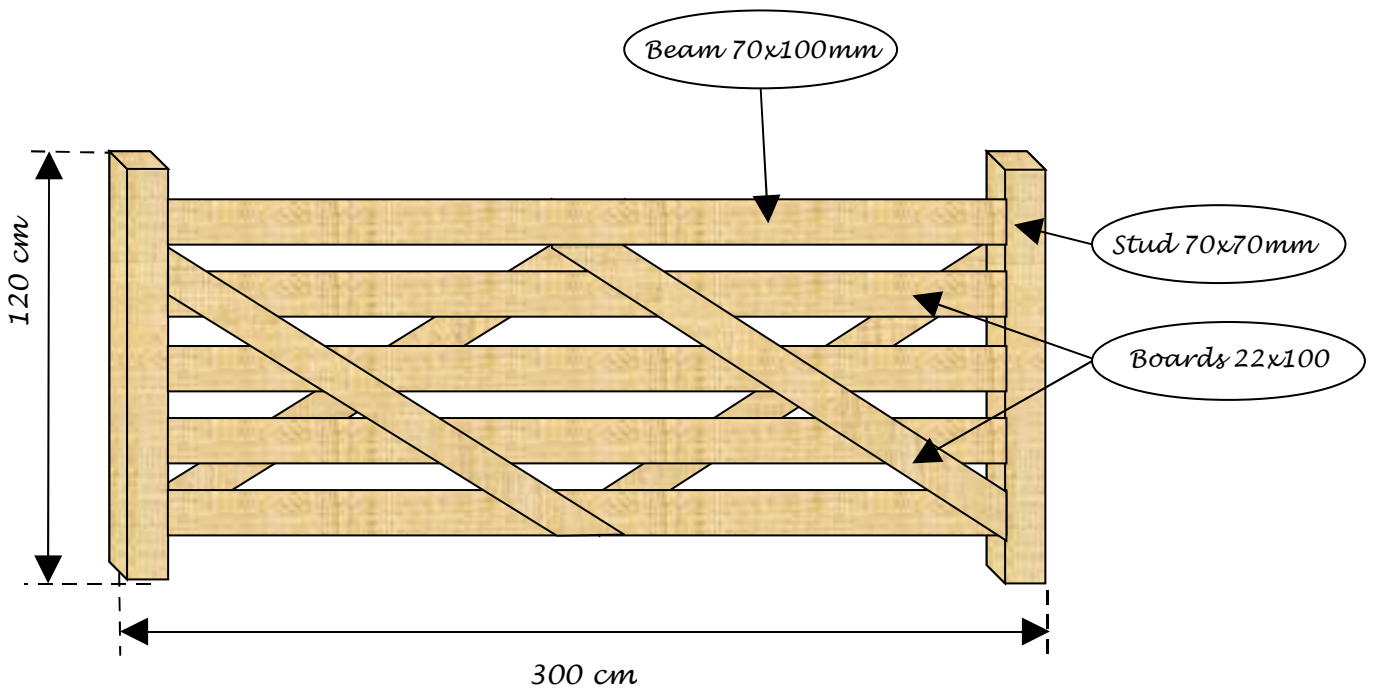

Art. 23.1 - GATE 120 x 300 cm:

- 2 square section, planed studs 7x7 cm, height 120 cm
- 1 cross beam 70x100 mm
- 8 boards 22x100 mm

Art. 23.2 - GATE 120 x 400 cm:

- 2 square section, planed studs 7x7 cm, height 120 cm
- 1 cross beam 70x100 mm
- 8 boards 22x100 mm

WOODEN STABLE BOX *module C*

pressure treated timber, pine, class IV

ABRI POUR CHEVAL traité autoclave cl. IV

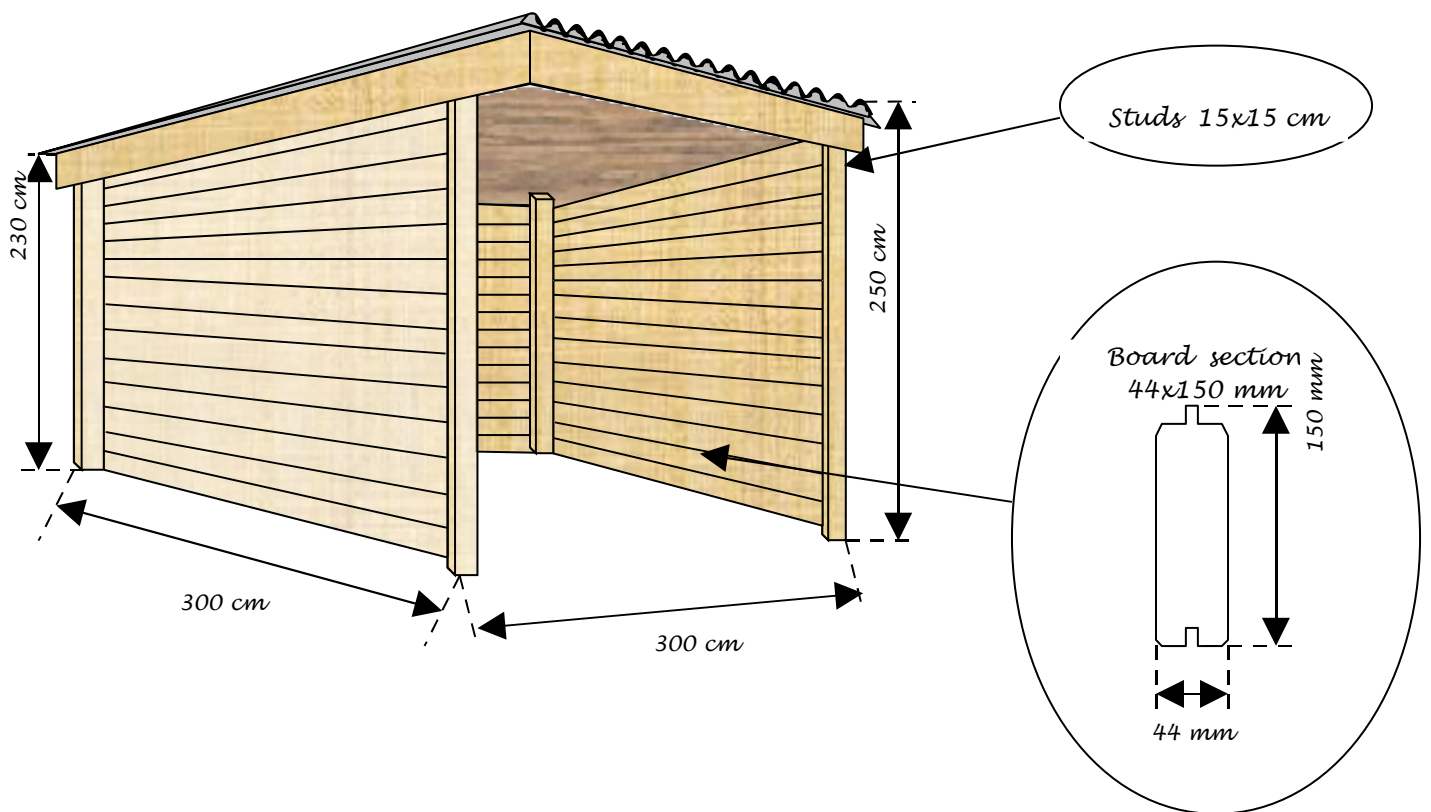

Art. 24.1 - Stable Box module

- height 230/250 cm
- plan size 300 x 300 cm

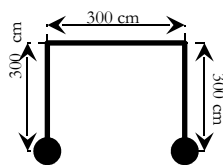

Art. 24.2 - Stable Box (2 modules)

- height 230/250 cm
- plan size 300 x 600 cm

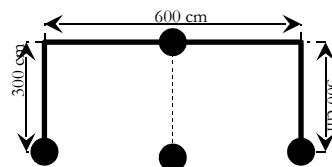

Art. 24.3 - Stable Box (2 modules)

- height 230/250 cm
- plan size 300 x 700 cm

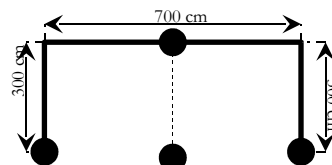

Art. 24.4 - Stable Box (3 modules)

- height 230/250 cm

— plan size 300 x 900 cm

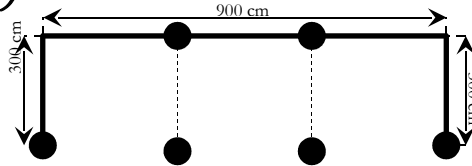

Art. 24.5 - Stable Box (4 modules)

- height 230/250 cm

— plan size 300 x 1200 cm

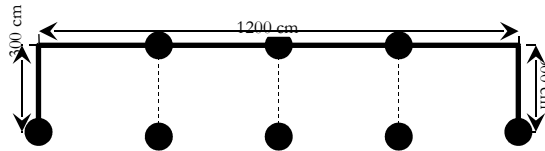

Art. 24.6 - Stable Box (5 modules)

- height 230/250 cm

— plan size 300 x 1500 cm

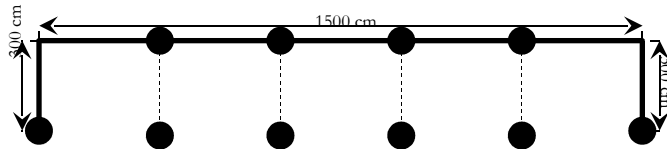

Art. 24.7 - Stable Box (6 modules)

- height 230/250 cm

— plan size 300 x 1800 cm

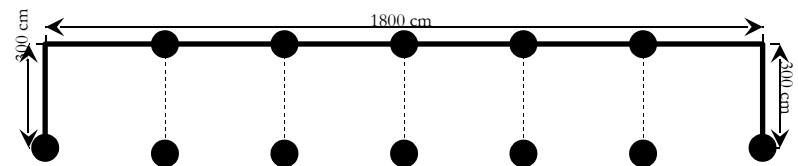

WOODEN STABLE BOX *module G*

pressure treated timber, pine, class IV

BOX POUR CHEVAL traité autoclave cl. IV

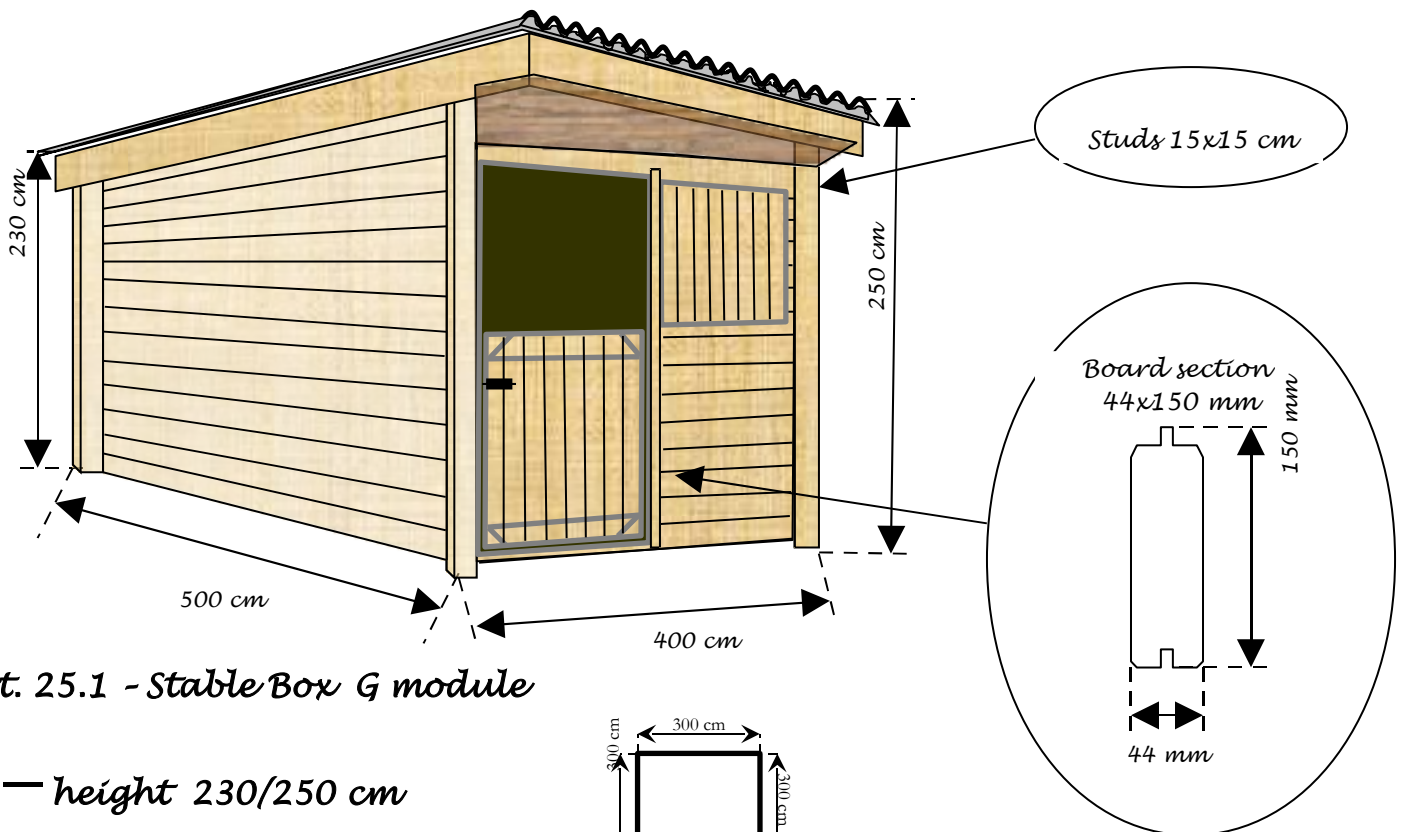

Art. 25.1 - Stable Box G module

- height 230/250 cm
- plan size 300 x 300 cm

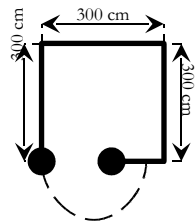

Art. 25.2 - Stable Box (2 modules)

- height 230/250 cm
- plan size 300 x 600 cm

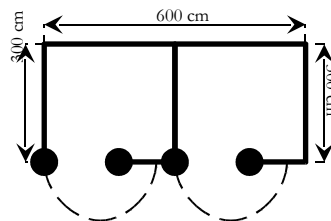

Art. 25.3 - Stable Box (2 modules)

- height 230/250 cm
- plan size 300 x 700 cm

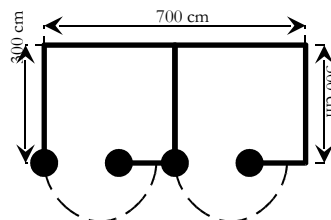

Art. 25.4 - Stable Box (3 modules)

- height 230/250 cm

— plan size 300 x 900 cm

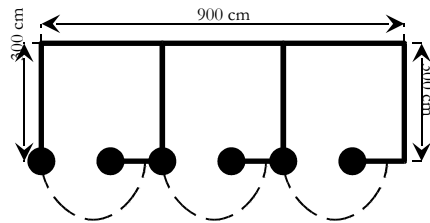

Art. 25.5 - Stable Box (4 modules)

- height 230/250 cm

— plan size 300 x 1200 cm

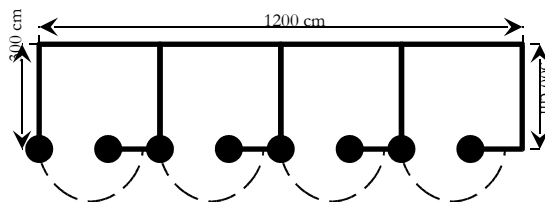

Art. 25.6 - Stable Box (5 modules)

- height 230/250 cm

— plan size 300 x 1500 cm

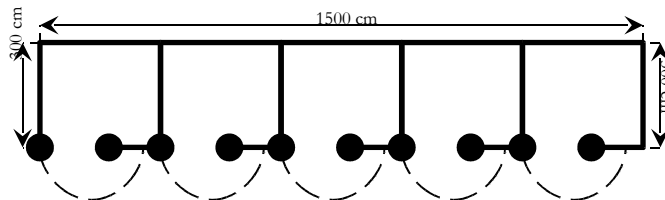

Art. 25.7 - Stable Box (6 modules)

- height 230/250 cm

— plan size 300 x 1800 cm

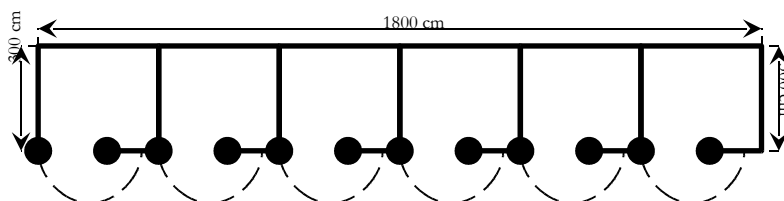

WOODEN STABLE BOX MIX (module C+G)

pressure treated timber, pine, class IV

MIX - BOXES + ABRIS traité autoclave cl. IV

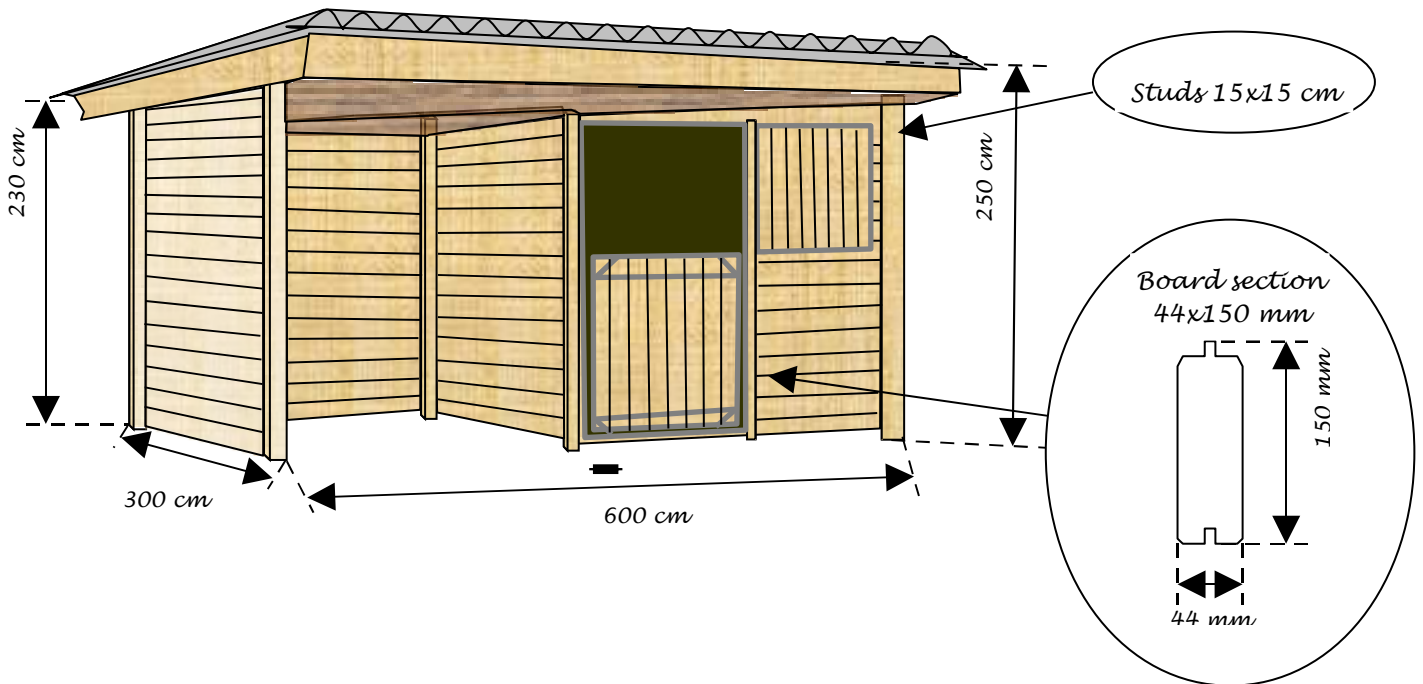

Art. 26.1 - Stable Box MIX (module s C+G)

- height 230/550 cm
- C module - plan size - 300 x 300 cm
- G module - plan size - 300 x 300 cm

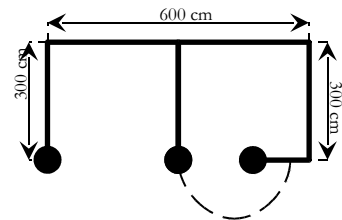

Art. 26.2 - Stable Box MIX (module s C+2G)

- height 230/550 cm
- 2G module - plan size - 300 x 600 cm
- C module - plan size - 300 x 300 cm

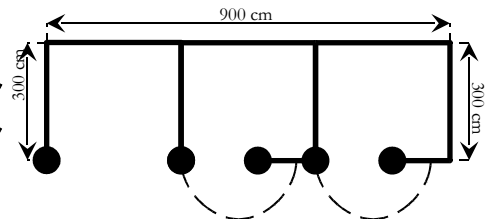

Art. 26.3 - Stable Box MIX (module s 2C+2G)

- height 230/550 cm
- 2G module - plan size - 300 x 600 cm
- 2C module - plan size - 300 x 600 cm

